

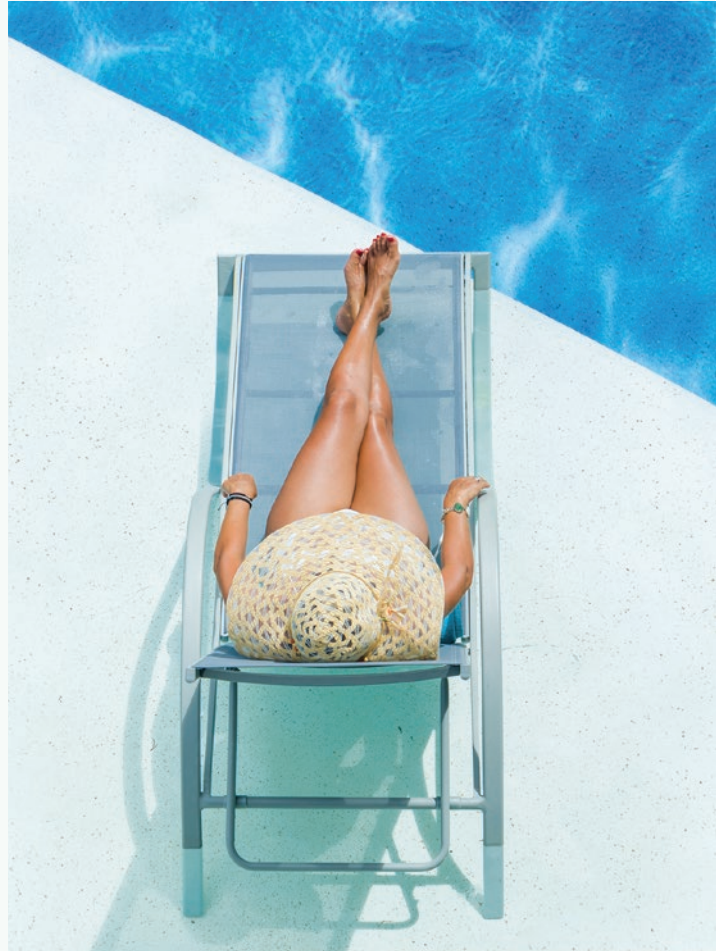

INSTALL CONFIDENCE



YORK<sup>®</sup> RAC, PAC & VRF 2017



A more comfortable,  
safe and sustainable world

# RAC, PAC & VRF

## Air-conditioning solutions

Every market is unique in air-conditioning requirements. In this catalogue our customers will be able to select the different options for residential market and VRF solutions for Light-Commercial market.

Johnson Controls wants to offer all the possible solutions for different building design and technical requirements, and the air-conditioning is an important part of those global solutions.



### MINISPLIT SOLUTIONS

- High Wall inverter
- Multisplit inverter
- Floor/ceiling inverter
- Cassette inverter
- Blower inverter



The majority of our products are already rated as Class A or more for Energy Efficiency, in order to guarantee lower consumption.

According to the market necessities our customers can find the best solution in our wide product range depending on the building characteristics.

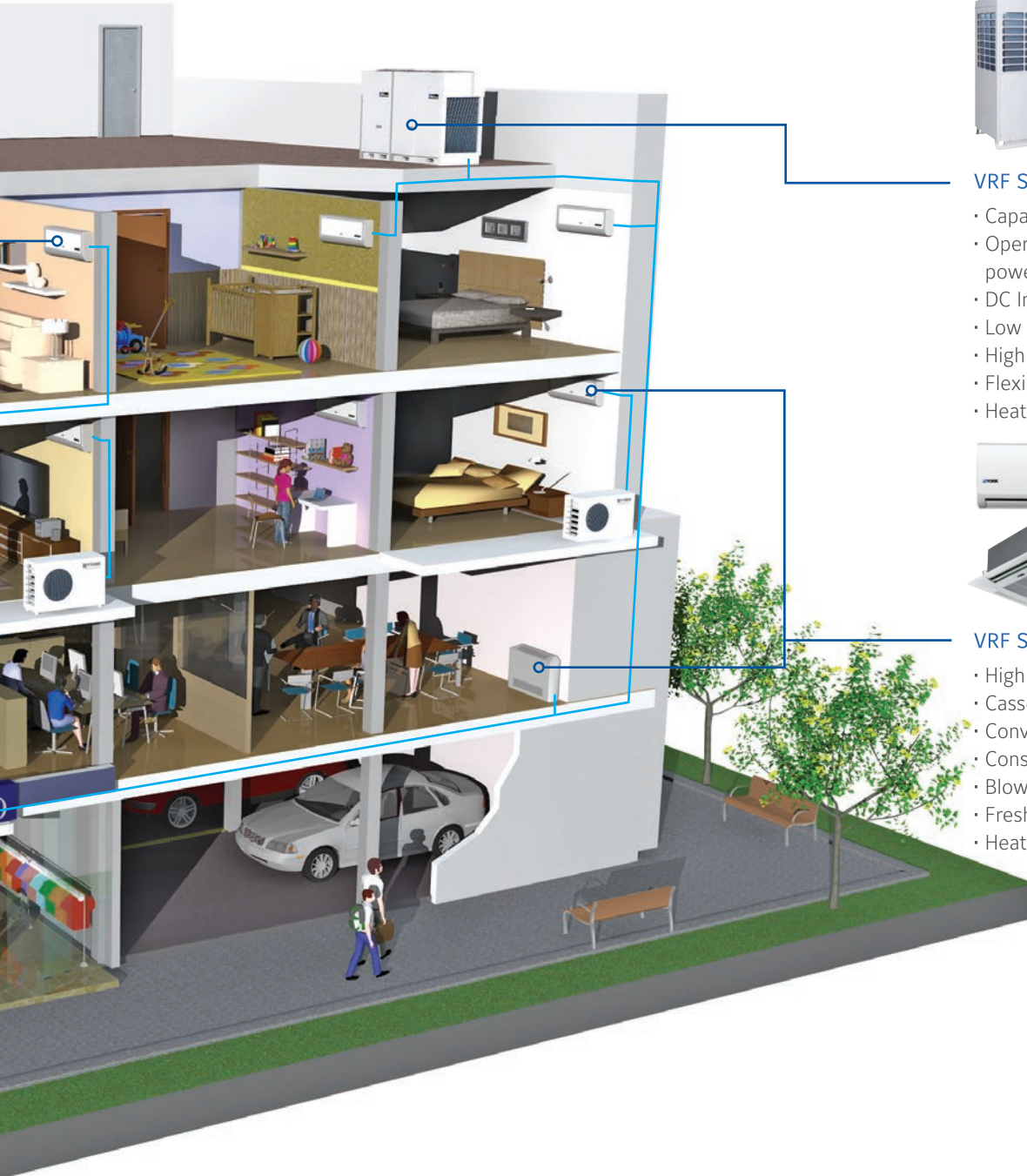

**VRF SOLUTIONS (Outdoor units)**

- Capacities from 9 to 211 kW
- Operating range of nominal power (10% - 130 %)
- DC Inverter Scroll Technology
- Low noise levels
- High performance
- Flexible and quickly installation
- Heat recovery



**VRF SOLUTIONS (Indoor units)**

- High Wall
- Cassette
- Convertible console floor/ceiling
- Console
- Blower
- Fresh air
- Heat recovery

# Catalogue content

## Split Systems

		Pag.
High wall Inverter R32	<b>YHKF 09 to 24 ZEEBMHORX</b>	16
High wall Inverter Pyrenees	<b>YHKE 09 to 24 ZEEAMHORX</b>	18
High wall Inverter Monte Rosa	<b>YHKE 09 to 24 ZE-MJORX</b>	20
Multi Inverter "Free Indoor Units"	<b>YJU_YH 14 to 45</b>	22
Floor/Ceiling Inverter	<b>YFKE 18 to 55</b>	26
Cassette Inverter	<b>YTKE 12 to 18 BZE / YKKE 18 to 55 BZE(O)</b>	28
Blower Inverter Medium Static Pressure	<b>YEKE 12 to 55 BZE(O)</b>	30

## VRF Systems

VRF System High Efficiency	<b>YV2VYH 025 to 204</b>	34
Amazon Standard Ambient VRF System	<b>YV2V 010 to 135</b>	36

Cooling capacity kW

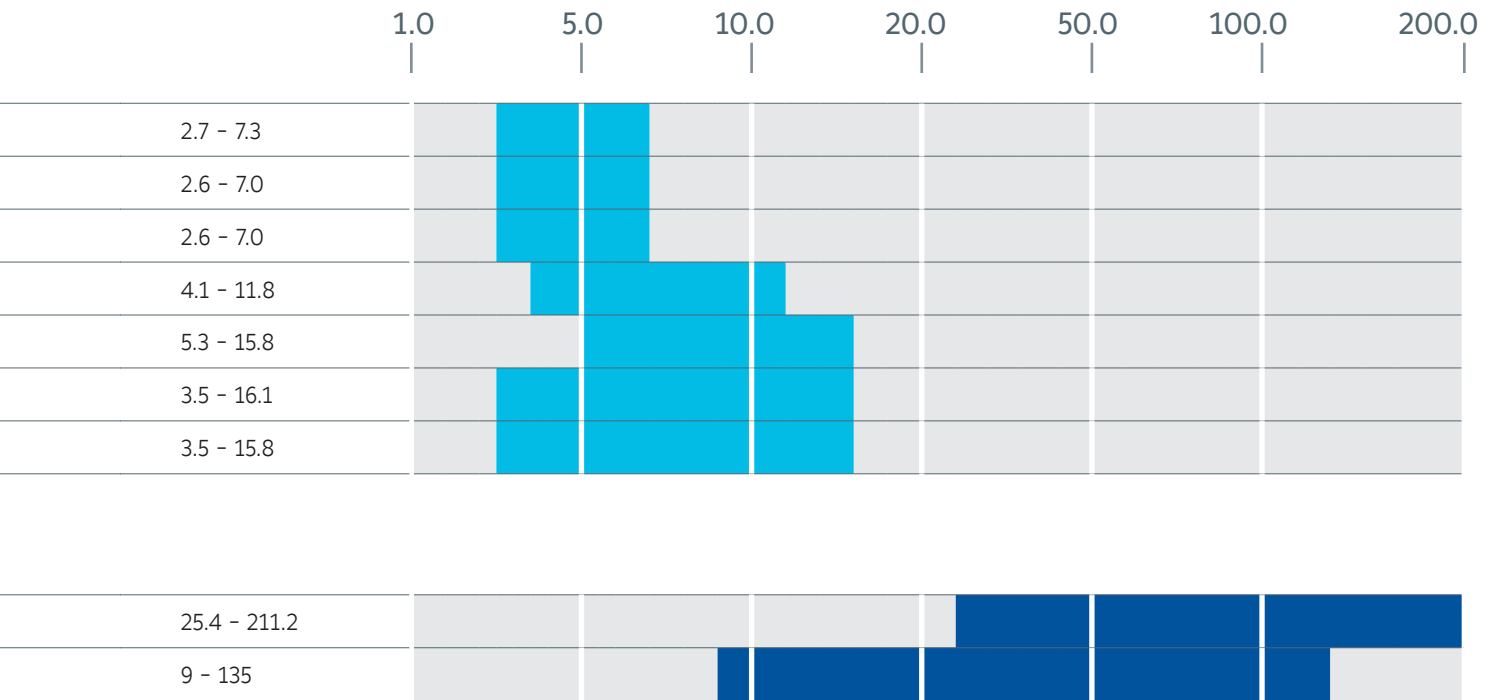



 **YORK**





## EFFICIENCY AND ECOLOGICAL INVERTER RANGE

The High Wall inverter air conditioners have been designed thinking about comfort and sustainability. Comfort as the ultimate technology of DC Inverter compressor installed in these units is able to achieve high performances in heating and cooling mode, the temperature variations in the room are minimized and the noise level is lower.

Sustainable because the high efficiency of the unit results in a very low energy consumption, one of the most efficient in the market, the materials used are recyclable and free of hazardous substances, all together makes this unit the appropriate choice for conditioning your home.

The R32 is the new refrigerant that has a zero impact on the ozone layer and a smaller impact on global warming.

We are sure that technology improves people's lives. This is why we introduce a new generation of air conditioners with R32, an innovative refrigerant in every imaginable way: easy to install, environmentally friendly and energy saving.





# Main Features

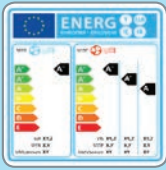

### EU Energy Label A Class

With the powerful compressor and optimized refrigerant, the SEER can reach EU Energy Label A Class (over 5.1 w/w) or B Class (over 4.6 w/w), greatly reducing the power consumption.



### Auto-Restart Function

When the power supply is interrupted and then restored, the air conditioners automatically restore the previous function setting.



### Turbo Mode

Press the Turbo button and the A/C will reach the preset temperature in the shortest time.



### WiFi control

With the WiFi control, you can easily turn off the AC outside your house via smart device. Furthermore, you can turn it on before you come back.



### Sleep Mode

With Sleep Mode, the air conditioner's set temperature will automatically increase (cooling) or decrease (heating) 1°C per hour for the first two hours then hold steady for the next 5 hours after which the air conditioner will stop operation. With the sleep mode function can maintain the most comfortable temperature and save energy.



### Low Ambient Kit

The air conditioning unit can operate in cooling mode at low ambient temperature conditions. The kit is suitable for special applications such as computer and power station control rooms where cooling is required even in the winter months.



### Dehumidification

Independent dehumidification function is usually used in rainy days in springtime or damp areas. The unit will alternately operate in cooling mode or fan only mode, which assures strong dehumidification while not lowering room temperature.



### Anti-Rust Cabinet and Valve Protection Cover

Cabinet made from electrolytic zinc steel sheet and anti-rust coated components. York's outdoor units are rust free even in coastal regions. The valve protection cover protects the service valves and prevents water from dripping.

## Iconography



Infrared control



Wired control



Infrared or Wired control



Dry mode



Sleep mode



Timer



Auto Sweep



Auto Restart



Turbo mode



Thin profile



Quiet



4 Way Air Flow



Floor/Ceiling



Ducted Installation



Air Filter



Low Ambient Kit

# Range Capacities

2.0 2.5 3.0 3.5 4.0 4.5 5.0 5.5 6.0 6.5 7.0 7.5 8.0 8.5 9.0 9.5 10.0



\* ErP documents for product below 12kW available in <https://virtualbranch.johnsoncontrols.com/vb/catalog/HVAC-Equipment/6/Minisplits/33>

10.0 10.5 11.0 11.5 12.0 12.5 13.0 13.5 14.0 14.5 15.0 15.5 16.0 16.5 17.0 17.5 18.0 18.5 **kW**

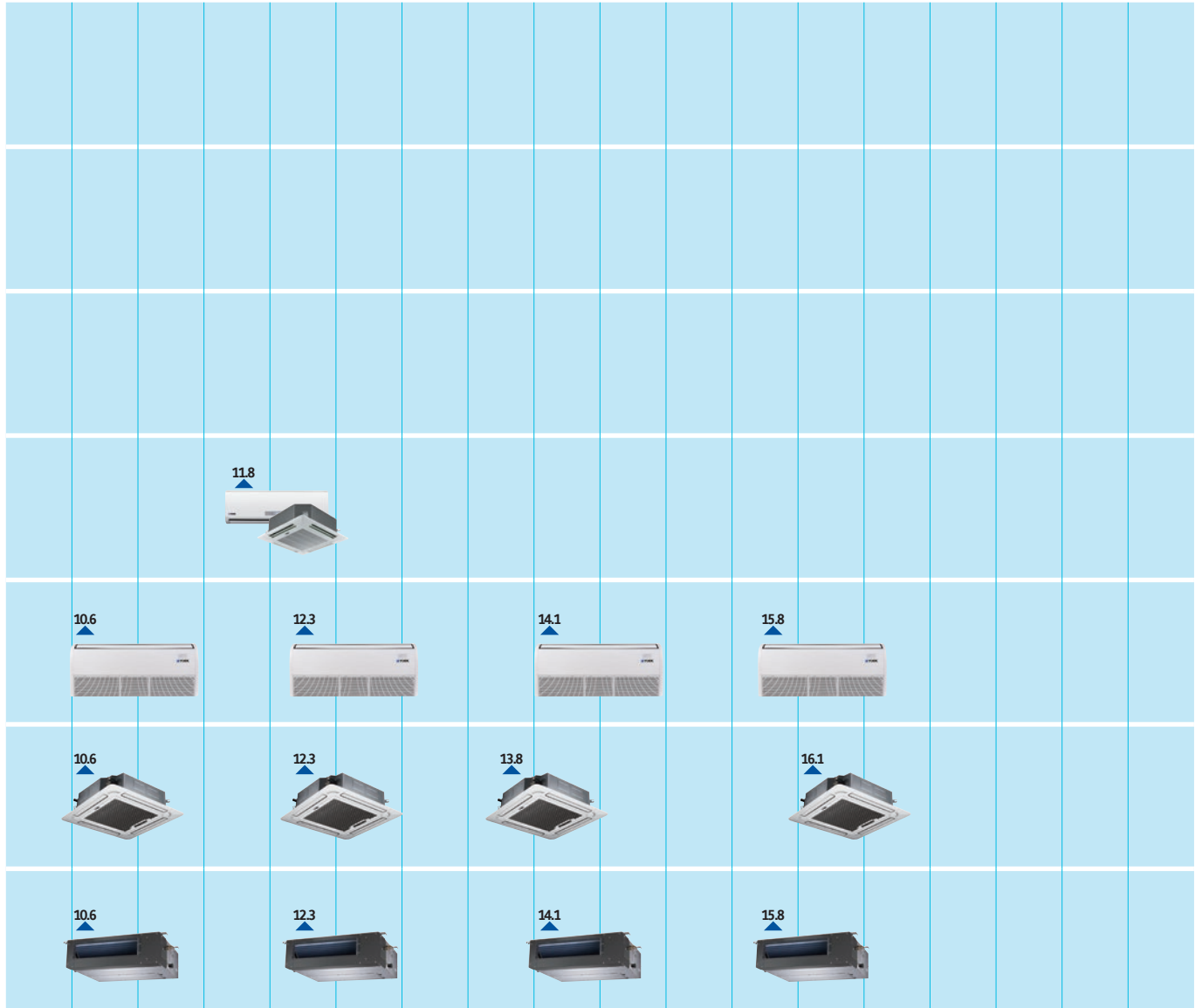



# Minisplit Inverter Systems

HIGH WALL INVERTER

FLOOR/CEILING INVERTER

CASSETTE INVERTER

BLOWER INVERTER

# High Wall Inverter

YHKF 09 to 24 ZEEBMHORX  
A complete range from 2.7 kW to 7.3 kW



## Features

- **R32 Refrigerant**
- High SEER & SCOP, Class A++
- DC Inverter compressor
- Low noise levels
- Multispeed fan
- Automatic restart
- Automatic air sweep
- LED display
- Two-way draining
- High density filter
- Low Ambient Kit
- Refrigerant leakage detect
- Service valve protection cover
- Rustproof casing
- **Blue fin protection (indoor and outdoor units)**



## Remote controller

- Wireless
- Follow me function
- 5 operation modes (Cool/Heat/Auto/Dry/Fan)
- 5 Fan speeds selection
- Quiet/sleep button
- ON/OFF timer
- Air flow direction setting
- LCD display
- Turbo mode
- Room temperature setting





# High Wall Inverter

## YHKF 09 to 24 ZEEBMHORX



### Technical features

Set reference		YHKF_ZEEBMHORX				
Indoor unit	Sizes	YHKF09XEEMH-RX	YHKF12XEEMH-RX	YHKF18XEEMH-RX	YHKF24XEEMH-RX	
Outdoor unit	Sizes	YHKF09YEEBMHO-X	YHKF12YEEBMHO-X	YHKF18YEEBMHO-X	YHKF24YEEBMHO-X	
Cooling capacity	kW	2.7 (1.0-3.2)	3.5 (0.8-4.2)	5.3 (1.7-6.2)	7.3 (2.6-8.4)	
Heating capacity	kW	2.9 (0.9-3.7)	3.8 (0.8-4.8)	5.6 (1.1-7.0)	7.6 (1.5-9.4)	
Compressor	Type	Rotary				
Refrigerant		R32				
Power supply	V/Ph/Hz	230 / 1 / 50 + E				
Power input	cooling	0.07 ~ 1.23	0.05 ~ 1.60	0.12 ~ 2.39	0.23 ~ 3.35	
	heating	0.14 ~ 1.31	0.13 ~ 1.71	0.19 ~ 2.49	0.23 ~ 3.37	
SEER		7.1	7.5	6.7	6.9	
SCOP		4.0	4.2	4.0	4.0	
Energy Class	cooling	A++	A++	A++	A++	
	heating	A+	A+	A+	A+	
Indoor airflow	m³/h	521 / 429 / 259	539 / 478 / 294	750 / 505 / 420	1050 / 750 / 560	
Sound pressure at 1 m	Indoor (H/M/L)	dB(A)	37 / 29.5 / 22	38 / 30 / 22	42 / 33 / 27	46 / 40 / 30
	Outdoor	dB(A)	55	55	57	59
Dimensions	Indoor	H (mm)	290	297	319	335
		W (mm)	722	802	965	1 080
		D (mm)	187	189	215	226
	Outdoor	H (mm)	555	555	554	700
		W (mm)	770	770	800	845
		D (mm)	300	300	333	320
Net weight	Indoor unit	kg	7.4	8.2	9	12
	Outdoor unit	kg	26.4	26.5	37	48
Piping	Type of connection	Flare				
	Diameter	Gas	3/8"	3/8"	1/2"	5/8"
Liquid		1/4"	1/4"	1/4"	3/8"	
Refrigerant charge	g	700	800	1 250	1 600	
Pipe run	Length	m	25	25	30	50
	Height	m	10	10	20	25
Operating limit - cooling mode	min./max.	-15°C / +50°C				
Operating limit - heating mode	min./max.	-15°C / +30°C				

Nominal cooling capacity based on : - Indoor Air Temp. 27°C DB / 19°C WB - Outdoor Air Temp. 35°C DB

Nominal heating capacity based on : - Indoor Air Temp. 21°C DB - Outdoor Air Temp. 7°C DB/6°C WB

Piping length : 5 m with initial charge

### Accessories

Sizes	09	12	18	24
Wired control			Optional	
Central control			Optional	



Manufacturer reserves the rights to change specifications without prior notice.

# High Wall Inverter Pyrenees

YHKE 09 to 24 ZEEAMHORX  
A complete range from 2.6 kW to 7.0 kW



## Features

- High SEER & SCOP, Class A++
- DC Inverter compressor
- Low noise levels
- Multispeed fan
- Automatic restart
- Automatic air sweep
- LED display
- Two-way draining
- High density filter
- Low Ambient Kit
- Refrigerant leakage detect
- Service valve protection cover
- Rustproof casing
- **Blue fin protection (indoor and outdoor units)**

## Remote controller



- Wireless
- Follow me function
- 5 operation modes (Cool/Heat/Auto/Dry/Fan)
- 5 Fan speeds selection
- Quiet/sleep button
- ON/OFF timer
- Air flow direction setting
- LCD display
- Turbo mode
- Room temperature setting



# High Wall Inverter Pyrenees

YHKE 09 to 24 ZEEAMHORX



## Technical features

Set reference			YHKE_ZEEAMHORX			
Indoor unit	Sizes	YHKE09XEEAMH-RX	YHKE12XEEAMH-RX	YHKE18XEEAMH-RX	YHKE24XEEAMH-RX	
Outdoor unit	Sizes	YHKE09YEEAMHO-X	YHKE12YEEAMHO-X	YHKE18YEEAMHO-X	YHKE24YEEAMHO-X	
Cooling capacity	kW	2.6 (1.2-3.3)	3.5 (1.4-4.5)	5.3 (1.8-6.2)	7.0 (2.7-8.1)	
Heating capacity	kW	2.9 (0.9-3.8)	3.8 (1.1-4.9)	5.6 (1.4-9.4)	7.9 (2.2-9.3)	
Compressor	Type	Rotary				
Refrigerant		R410A				
Power supply	V/Ph/Hz	230 / 1 / 50 + E				
Power input	cooling	kW	0.75 (0.09-1.27)	1.13 (0.1-1.74)	1.54 (0.15-2.38)	2.26 (0.23-3.11)
	heating	kW	0.75 (0.14-1.34)	1.06 (0.17-1.76)	1.50 (0.22-2.43)	2.32 (0.32-3.32)
SEER		7.4	6.8	6.8	6.6	
SCOP		4.2	4.2	4.0	4.0	
Energy Class	cooling	A++	A++	A++	A++	
	heating	A+	A+	A+	A+	
Indoor airflow	m³/h	420 / 310 / 240	520 / 460 / 270	750 / 500 / 420	1 060 / 830 / 610	
Sound pressure at 1 m	Indoor (H/M/L)	dB(A)	37 / 33 / 23	39 / 35 / 24	42 / 34 / 29	48 / 43 / 32
	Outdoor	dB(A)	58	60	62	66
Dimensions	Indoor	H (mm)	290	297	319	335
		W (mm)	722	802	965	1 080
		D (mm)	187	189	215	226
	Outdoor	H (mm)	555	554	554	702
		W (mm)	770	800	800	845
		D (mm)	300	333	333	363
Net weight	Indoor unit	kg	7.4	8.2	10.7	13
	Outdoor unit	kg	26.6	29.1	37.8	48.4
Piping	Type of connection	Flare				
	Diameter	Gas	3/8"	3/8"	1/2"	5/8"
Liquid		1/4"	1/4"	1/4"	3/8"	
Refrigerant charge	g	800	950	1 480	2 000	
Pipe run	Length	m	25	25	30	50
	Height	m	10	10	20	25
Operating limit - cooling mode	min./max.	-15°C / +50°C				
Operating limit - heating mode	min./max.	-15°C / +30°C				

Nominal cooling capacity based on : - Indoor Air Temp. 27°C DB / 19°C WB - Outdoor Air Temp. 35°C DB

Nominal heating capacity based on : - Indoor Air Temp. 21°C DB - Outdoor Air Temp. 7°C DB/6°C WB

Piping length : 5 m with initial charge

## Accessories

Sizes	09	12	18	24
Wired control			Optional	
Central control			Optional	



Manufacturer reserves the rights to change specifications without prior notice.

# High Wall Inverter Monte Rosa

YHKE 09 to 24 ZE-MJORX

A complete range from 2.6 kW to 7.0 kW



## Features

- High SEER & SCOP, Class A++
- DC Inverter compressor
- Low noise levels
- Multispeed fan
- Automatic restart
- Automatic air sweep
- LED display
- Two-way draining
- High density filter
- Low Ambient Kit
- Refrigerant leakage detect
- Service valve protection cover
- Rustproof casing
- **Blue fin protection (indoor and outdoor units)**



## Remote controller

- Wireless
- Follow me function
- 5 operation modes (Cool/Heat/Auto/Dry/Fan)
- 5 Fan speeds selection
- Quiet/sleep button
- ON/OFF timer
- Air flow direction setting
- LCD display
- Turbo mode
- Room temperature setting



# High Wall Inverter Monte Rosa

YHKE 09 to 24 ZE-MJORX



## Technical features

Set reference		YHKE_ZE-MJORX				
Indoor unit	Sizes	YHKE09XE-MJ-RX	YHKE12XE-MJ-RX	YHKE18XE-MJ-RX	YHKE24XE-MJ-RX	
Outdoor unit	Sizes	YHKE09YE-MJO-X	YHKE12YE-MJO-X	YHKE18YE-MJO-X	YHKE24YE-MJO-X	
Cooling capacity	kW	2.6 (1.0-3.2)	3.5 (1.1-4.1)	5.3 (1.8-6.1)	7.0 (2.7-7.9)	
Heating capacity	kW	2.9 (0.8-3.4)	3.8 (0.9-4.2)	5.6 (1.4-6.7)	7.3 (1.6-8.8)	
Compressor	Type	Rotary				
Refrigerant		R410A				
Power supply	V/Ph/Hz	230 / 1 / 50 + E				
Power input	cooling	0.1 ~ 1.24	0.1 ~ 1.58	0.14 ~ 2.36	0.24 ~ 3.03	
	heating	0.12 ~ 1.20	0.13 ~ 1.51	0.2 ~ 2.41	0.26 ~ 3.14	
SEER		6.2	6.1	6.4	6.1	
SCOP		4.0	4.0	4.0	4.0	
Energy Class	cooling	A++	A++	A++	A++	
	heating	A+	A+	A+	A+	
Indoor airflow	m³/h	420 / 320 / 270	570 / 470 / 370	840 / 680 / 540	980 / 800 / 640	
Sound pressure at 1 m	Indoor (H/M/L)	40 / 34 / 29.5	41 / 36 / 28	47 / 40 / 35	45 / 39 / 34	
	Outdoor	55.5	56	56	60	
Dimensions	Indoor	H (mm)	285	285	302	327
		W (mm)	715	805	957	1 040
		D (mm)	194	194	213	220
	Outdoor	H (mm)	555	555	554	702
		W (mm)	770	770	800	845
		D (mm)	300	300	333	363
Net weight	Indoor unit	6.8	7.2	9.5	11.9	
	Outdoor unit	25.2	25.5	37.8	48.4	
Piping	Type of connection	Flare				
	Diameter	Gas	3/8"	3/8"	1/2"	5/8"
Liquid		1/4"	1/4"	1/4"	3/8"	
Refrigerant charge	g	800	800	1 480	1 850	
Pipe run	Length	25	25	30	50	
	Height	10	10	20	25	
Operating limit - cooling mode	min./max.	-15°C / +50°C				
Operating limit - heating mode	min./max.	-15°C / +30°C				

Nominal cooling capacity based on : - Indoor Air Temp. 27°C DB / 19°C WB - Outdoor Air Temp. 35°C DB

Nominal heating capacity based on : - Indoor Air Temp. 21°C DB - Outdoor Air Temp. 7°C DB/6°C WB

Piping length : 5 m with initial charge

## Accessories

Sizes	09	12	18	24
Wired control			Optional	
Central control			Optional	



Manufacturer reserves the rights to change specifications without prior notice.

# Multi Inverter Free Indoor Units

YJU\_YH 014 to 045

A complete range from 4.1 kW to 11.8 kW



## Features

- High SEER & SCOP, Class A or more
- DC inverter compressor
- Free match indoor/outdoor
- Automatic restart
- ON/OFF timer
- Automatic air sweep
- Valve protection cover
- Single general valve design (25K/30K/34K)
- **Blue fin protection (indoor and outdoor units)**



## Remote controller

- Wireless
- 5 operation modes (Cool/Heat/Auto/Dry/Fan)
- Sleep mode
- On/Off timer
- Turbo cool/heat settings
- Fan speed selection
- Air flow direction setting
- LED display
- Lock button

## Indoor units



# Multi Inverter Free Indoor Units

YJU\_YH 014 to 045



## Technical features Outdoor units

Model		YJU_YH							
Outdoor units	Sizes	YJU2YH014	YJU2YH018	YJU3YH019	YJU4YH025	YJU4YH030	YJU5YH034	YJU5YH045	
Indoor units	number	2 indoor units	2 indoor units	3 indoor units	4 indoor units	4 indoor units	5 indoor units	5 indoor units	
Cooling capacity	kW	4.1 (1.2 ~ 4.5)	5.1 (1.3 ~ 5.8)	5.3 (1.5 ~ 7.0)	7.4 (1.5 ~ 9.0)	8.5 (1.5 ~ 9.8)	9.7 (1.5 ~ 11.0)	11.8 (1.5 ~ 13.4)	
Heating capacity	kW	4.4 (1.5 ~ 5.0)	5.8 (1.9 ~ 6.6)	6.3 (1.8 ~ 8.1)	8.3 (1.8 ~ 9.5)	9.5 (1.8 ~ 10.5)	10.3 (1.8 ~ 11.5)	12.2 (1.8 ~ 14.0)	
Compressor	Type (Nb)	Rotary Inverter (1)							
Refrigerant		R410A							
Location of expansion device		Outdoor unit							
Power supply	V/Ph/Hz	230 / 1 / 50 + E							
Power input	cooling kW	1.07	1.54	1.39	2.10	2.41	2.94	2.94	
	heating kW	1.09	1.55	1.52	2.06	2.43	2.85	2.85	
EER		3.83	3.31	3.8	3.5	3.5	3.3	3.09	
SEER		6.1	6.1	6.6	6.6	6.6	6.6	6.6	
COP		4.03	3.74	4.30	3.80	4.00	3.90	3.80	
SCOP		4.0	4.0	4.0	4.0	4.0	4.0	3.8	
Energy Class	cooling	A++	A++	A++	A++	A++	A++	A++	
	heating	A+	A+	A+	A+	A+	A+	A	
Airflow (outdoor unit)	m³/h	1 900	2 900	2 000	3 500	4 000	4 000	4 200	
Sound pressure level	dB(A)	62	63	52	56	56	58	60	
Dimensions outdoor unit	Height	mm	540	688	688	840	840	840	830
	Width	mm	780	810	886	948	948	948	1 008
	Depth	mm	270	288	289	340	340	340	447
Net weight outdoor unit	kg	38	43.5	51	74	76	77	90	
Piping	Type of connection		Flare						
	Diameter	Gas	3/8"	3/8"	3 x 3/8"	3 x 3/8" + 1 x 1/2"	3 x 3/8" + 1 x 1/2"	4 x 3/8" + 1 x 1/2"	3 x 3/8" + 2 x 1/2"
		Liquid	1/4"	1/4"	3 x 1/4"	4 x 1/4"	4 x 1/4"	5 x 1/4"	5 x 1/4"
Max pipe run *	Length	m	30	30	50	70	70	80	100
	Height	m	15	15	15	15	15	15	15
Refrigerant charge	g	1 200	1 400	2 000	3 100	3 200	3 400	3 200	
Operating limits cooling mode	min/max	-10°C / +46°C							
Operating limits heating mode	min/max	-15°C / +24°C							

\* values for all the system (all indoor units connected)

Nominal cooling capacity based on : - Indoor Air Temp. 27°C DB / 19°C WB - Outdoor Air Temp. 35°C DB

Nominal heating capacity based on : - Indoor Air Temp. 21°C DB - Outdoor Air Temp. 7°C DB/6°C WB

Piping length : 5 m with initial charge (each indoor unit)



Manufacturer reserves the rights to change specifications without prior notice.

# Indoor units technical features



## High Wall

### Features

- Automatic restart
- Automatic air sweep

Indoor units		Sizes	YJHMXH				
			07 *	09 *	12	18	24
Cooling capacity		kW	2.0	2.7	3.6	5.2	7.0
Heating capacity		kW	2.2	2.8	3.7	5.8	7.5
Power supply		V/Ph/Hz	230 / 1 / 50 + E				
Indoor airflow		m <sup>3</sup> /h	600	600	650	900	1 200
Sound pressure level	H / M / L	dB(A)	38 / 33 / 26	38 / 33 / 26	39 / 34 / 27	44 / 40 / 35	47 / 43 / 37
Dimensions	H / W / D	mm	280 / 855 / 204	280 / 855 / 204	280 / 855 / 204	322 / 997 / 235	336 / 1115 / 248
Net Weight		kg	10	10	10	13	16
		Type of connection	Flare				
Piping	Diameter	Gas	3/8"	3/8"	3/8"	1/2"	5/8"
		Liquid	1/4"	1/4"	1/4"	1/4"	1/4"



### Features

- Floor/Ceiling
- Automatic air sweep

## Floor / Ceiling

Indoor units		Sizes	YHFMXH		
			12	18	24
Cooling capacity		kW	3.5	5.0	6.3
Heating capacity		kW	3.9	5.5	7.1
Power supply		V/Ph/Hz	230 / 1 / 50 + E		
Indoor airflow		m <sup>3</sup> /h	650	800	800
Sound pressure level	H / M / L	dB(A)	41 / 37 / 33	44 / 41 / 36	48 / 45 / 42
Dimensions	H / W / D	mm	665 / 990 / 199	665 / 990 / 199	665 / 990 / 199
Net Weight		kg	26.3	28.3	28.3
		Type of connection	Flare		
Piping	Diameter	Gas	3/8"	1/2"	5/8"
		Liquid	1/4"	1/4"	3/8"



### Features

- Condensate pump included
- Automatic air sweep

## Cassette

Indoor units		Sizes	YHKMXH			
			09 *	12	18	24
Cooling capacity		kW	2.6	3.5	5.0	6.5
Heating capacity		kW	2.9	3.7	5.2	7.1
Power supply		V/Ph/Hz	230 / 1 / 50 + E			
Indoor airflow		m <sup>3</sup> /h	620	620	680	1 300
Sound pressure level	H / M / L	dB(A)	40 / 36 / 32	40 / 36 / 32	42 / 37 / 35	46 / 44 / 39
Dimensions unit	H / W / D	mm	260 / 570 / 570	260 / 570 / 570	260 / 570 / 570	240 / 840 / 840
Dimensions panel	H / W / D	mm	60 / 700 / 700	60 / 700 / 700	60 / 700 / 700	60 / 950 / 950
Net weight		kg	17	18.5	18.5	26.8
		Type of connection	Flare			
Piping	Diameter	Gas	3/8"	3/8"	1/2"	5/8"
		Liquid	1/4"	1/4"	1/4"	3/8"

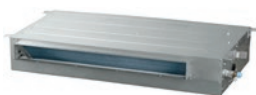

### Features

- Slim size
- Air filter included
- Wired control included

## Slim duct

Indoor units		Sizes	YH3MXH			
			09 *	12	18	24
Cooling capacity		kW	2.7	3.5	5.0	7.1
Heating capacity		kW	2.8	3.9	6.4	7.2
Power supply		V/Ph/Hz	230 / 1 / 50 + E			
Indoor airflow		m <sup>3</sup> /h	530	600	900	1 100
Static pressure		Pa	30	30	30	30
Sound pressure level	H / M / L	dB(A)	33 / 29 / 26	35 / 31 / 27	36 / 30 / 26	39 / 32 / 29
Dimensions	H / W / D	mm	185 / 850 / 420	185 / 850 / 420	185 / 1 170 / 420	185 / 1 170 / 420
Net Weight		kg	15.9	15.9	25	27
		Type of connection	Flare			
Piping	Diameter	Gas	3/8"	3/8"	1/2"	5/8"
		Liquid	1/4"	1/4"	1/4"	3/8"



### Features

- Air filter included
- Wired control included

## Duct

Indoor units		Sizes	YHDMXH			
			09 *	12	18	24
Cooling capacity		kW	2.5	3.5	5.0	6.8
Heating capacity		kW	2.9	4.0	5.5	7.1
Power supply		V/Ph/Hz	230 / 1 / 50 + E			
Indoor airflow		m <sup>3</sup> /h	550	550	850	1 200
Static pressure		Pa	25	25	25	25
Sound pressure level	H / M / L	dB(A)	37 / 34 / 31	37 / 34 / 31	41 / 35 / 32	45 / 41 / 37
Dimensions	H / W / D	mm	220 / 610 / 483	220 / 610 / 483	220 / 1 090 / 500	220 / 1 090 / 500
Net Weight		kg	14	14	23	24.5
		Type of connection	Flare			
Piping	Diameter	Gas	3/8"	3/8"	1/2"	5/8"
		Liquid	1/4"	1/4"	1/4"	3/8"



# Indoor unit combinations

YJU2YH014 (2x1)

Number connecting units	
2 x 1	
7+7	9+9
7+9	9+12
7+12	

YJU2YH018 (2x1)

Number connecting units	
2 x 1	
7+7	9+9
7+9	9+12
7+12	12+12

YJU3YH019 (3x1)

Number connecting units			
2 x 1		3 x 1	
7+7	9+12	7+7+7	7+9+12
7+9	9+18	7+7+9	7+12+12
7+12	12+12	7+7+12	9+9+9
7+18	12+18	7+7+18	9+9+12
9+9		7+9+9	9+12+12

YJU4YH025 (4x1)

Number connecting units					
2 x 1		3 x 1		4 x 1	
7+18	12+18	7+7+9	7+12+18	7+7+7+7	7+7+9+12
7+24	12+24	7+7+12	9+9+9	7+7+7+9	7+9+9+9
9+18	18+18	7+7+18	9+9+12	7+7+7+12	7+9+9+12
9+24	18+24	7+7+24	9+9+18	7+7+7+18	9+9+9+9
12+12		7+9+9	9+12+12	7+7+9+9	9+9+9+12
		7+9+12	12+12+12		
		7+9+18	12+12+18		
		7+12+12			

YJU4YH030 (4x1)

Number connecting units					
2 x 1		3 x 1		4 x 1	
7+24	12+24	7+7+18	9+9+18	7+7+7+7	7+9+9+9
9+18	18+18	7+7+24	9+9+24	7+7+7+9	7+9+9+12
9+24	18+24	7+9+12	9+12+12	7+7+7+12	7+9+9+18
12+18	24+24	7+9+18	9+12+18	7+7+7+18	9+9+12+12
		7+9+24	9+12+24	7+7+7+24	7+12+12+12
		7+12+12	12+12+12	7+7+9+9	9+9+9+9
		7+12+18	12+12+18	7+7+9+12	9+9+9+12
		7+12+24	12+12+24	7+7+9+18	9+9+12+12
		9+9+9	12+18+18	7+7+9+24	9+9+12+18
		9+9+12		7+7+12+12	9+12+12+12
				7+7+12+18	12+12+12+12

YJU5YH034 (5x1)

Number connecting units					
2 x 1	3 x 1		4 x 1		5 x 1
7+18	7+7+12	9+9+12	7+7+7+7	7+9+9+9	7+7+7+7+7
7+24	7+7+18	9+9+18	7+7+7+9	7+9+9+12	7+7+7+7+9
9+18	7+7+24	9+9+24	7+7+7+12	7+9+9+18	7+7+7+7+12
9+24	7+9+9	9+12+12	7+7+7+18	7+9+12+12	7+7+7+9+9
12+18	7+9+12	9+12+18	7+7+7+24	7+12+12+12	7+7+7+9+12
12+24	7+9+18	9+12+24	7+7+9+9	9+9+9+9	7+7+7+12+12
18+18	7+9+24	12+12+12	7+7+9+12	9+9+9+12	9+9+9+12+12
18+24	7+12+12	12+12+18	7+7+9+18	9+9+9+18	
24+24	7+12+18	12+12+24	7+7+9+24	9+9+12+12	
	7+12+24	12+18+18	7+7+12+12	9+12+12+12	
	9+9+9	18+18+18	7+7+12+18	12+12+12+12	

YJU5YH045 (5x1)

Number connecting units					
2 x 1	3 x 1		4 x 1		5 x 1
7+18	7+7+12	9+9+18	7+7+7+7	7+9+9+18	7+7+7+12+24
7+24	7+7+18	9+9+24	7+7+7+9	7+9+9+24	7+7+9+9+9
9+18	7+7+24	9+12+12	7+7+7+12	7+9+12+12	7+7+9+9+12
9+24	7+9+9	9+12+18	7+7+7+18	7+12+12+12	7+7+9+9+18
12+18	7+9+12	9+12+24	7+7+7+24	9+9+9+9	7+7+9+9+24
12+24	7+9+18	12+12+12	7+7+9+9	9+9+9+12	7+7+7+9+12
18+18	7+9+24	12+12+18	7+7+9+12	9+9+9+18	9+9+9+9+12
18+24	7+12+12	12+12+24	7+7+9+18	9+9+9+24	9+9+9+9+18
24+24	7+12+18	12+18+18	7+7+9+24	9+9+12+12	9+9+9+12+12
	7+12+24	12+18+24	7+7+12+12	9+9+12+18	7+7+7+12+18
	9+9+9	18+18+18	7+7+12+18	9+12+12+12	9+9+9+12+18
	9+9+12		7+7+12+24	9+12+12+18	
			7+9+9+9	9+12+12+24	
			7+9+9+12		

# Floor/Ceiling Inverter

YFKE 18 to 55

A complete range from 5.3 kW to 15.8 kW



## Features

- High SEER & SCOP, Class A++
- Inverter DC compressor and fan motor
- Washable filter
- Convertible - floor or ceiling
- Automatic restart
- Automatic air sweep
- Horizontal and vertical air sweep function
- Different swing angle design for cooling and heating
- 3D airflow
- Low Ambient Kit
- Service valve protection cover
- Rustproof casing
- Self diagnosis
- **Blue fin protection (indoor and outdoor units)**



## Remote controller

- Wireless
- Follow me function
- 5 operation modes (Cool/Heat/Auto/Dry/Fan)
- Sleep mode
- Room temperature setting
- Fan speed selection
- Timer setting function
- Air flow direction setting
- LCD display
- Turbo mode



# Floor/Ceiling Inverter

YFKE 18 to 55



## Technical features

Set reference		YFKE_ZEEBMORX							
Indoor unit	Sizes	YFKE 18	YFKE 24	YFKE 30	YFKE 36	YFKE 42	YFKE 48	YFKE 55	
Outdoor unit	Sizes	YUKE 18	YUKE 24	YUKE 30	YUKE 36	YUKE 42	YUKE 48	YUKE 55	
Cooling capacity	kW	5.3 (0.8 - 36.2)	7.0 (1.20 - 8.21)	8.8 (2.1 - 10.6)	10.6 (2.9 - 12.0)	12.3 (3.2 - 13.2)	14.1 (4.1 - 16.4)	15.8 (5.0 - 18.1)	
Heating capacity	kW	5.7 (0.9 - 7.0)	7.0 (1.20 - 8.65)	9.4 (2.1 - 10.8)	11.1 (2.6 - 13.2)	13.5 (3.0 - 14.7)	16.4 (4.4 - 18.5)	18.2 (5.3 - 20.5)	
Compressor	Type	Rotary							
Refrigerant		R410A							
Power supply	V/Ph/Hz	230 / 1 / 50			230 / 1 / 50 or 400 / 3 / 50			400 / 3 / 50	
Power input	cooling	kW	1630 (270 - 2365)	2285 (400 - 3155)	2960 (690 - 4055)	4060 (975 - 4620)	4230 (1070 - 5070)	5190 (1370 - 6310)	6060 (1660 - 6965)
	heating	kW	1460 (255 - 2510)	1900 (400 - 3090)	2475 (690 - 3870)	2985 (880 - 4690)	3540 (945 - 5000)	4810 (1465 - 6590)	5645 (1760 - 7320)
SEER		6.5	6.1	6.1	6.3	6.1	6.1	6.1	
SCOP		4.0	4.0	4.0	4.0	4.0	4.0	4.0	
Energy Class	cooling	A++	A++	A++	A++	A++	A++	A++	
	heating	A+	A+	A+	A+	A+	A+	A+	
Indoor airflow	m³/h	900 / 800 / 700	1180 / 1050 / 850	1650 / 1450 / 1250	2048 / 1767 / 1403	2271 / 1886 / 1394	2100 / 1800 / 1400	2250 / 1660 / 1280	
Sound pressure at 1 m	Indoor (H/M/L)	dB(A)	44 / 39 / 34	53 / 48 / 42	54 / 49 / 44	52 / 46 / 40	55 / 49 / 43	52 / 46 / 41	55 / 50 / 45
	Outdoor	dB(A)	56.5	60.5	59.5	61	62.5	65	62.5
Dimensions	Indoor	H (mm)	675	675	675	675	675	675	675
		W (mm)	1 068	1 068	1 280	1 650	1 650	1 650	1 650
		D (mm)	235	235	235	235	235	235	235
	Outdoor	H (mm)	554	702	810	810	810	1 333	1 333
		W (mm)	800	845	946	946	946	952	952
		D (mm)	333	363	410	410	410	410	410
Net weight	Indoor unit	kg	25.8	25	31	40.3	40.5	38.2	40.5
	Outdoor unit	kg	35.5	49	62.9	67.2	70.5	95.1	112.8
Piping	Type of connection		Flare						
	Diameter	Gas	1/2"	5/8"	5/8"	5/8"	5/8"	5/8"	5/8"
Liquid		1/4"	3/8"	3/8"	3/8"	3/8"	3/8"	3/8"	
Pipe run	Length	m	30	50	50	65	65	65	65
	Height	m	20	25	25	30	30	30	30
Operating limits - cooling mode		min/max	-15°C / +50°C						
Operating limits - heating mode		min/max	-15°C / +24°C						

Nominal cooling capacity based on : - Indoor Air Temp. 27°C DB / 19°C WB - Outdoor Air Temp. 35°C DB

Nominal heating capacity based on : - Indoor Air Temp. 21°C DB - Outdoor Air Temp. 7°C DB/6°C WB

Piping length : 5 m with initial charge

Size 36, 42 and 48: Values for single phase models.

## Accessories

Sizes	18	24	30	36	42	48	55
Wired control							Optional
Central control							Optional



Manufacturer reserves the rights to change specifications without prior notice.

# Cassette Inverter

YTKE 12 to 18 BZE / YKKE 18 to 55 BZE(O)

A complete range from 3.5 kW to 16.1 kW



## Features

- High SEER & SCOP, Class A++ mainly
- Inverter DC compressor and fan motor
- Special low noise fan design
- Washable filter
- Fresh air intake
- Built-in drain pump
- Automatic restart
- Automatic air sweep
- Low Ambient Kit
- Different swing angle design for cooling and heating
- Service valve protection cover
- Rustproof casing
- Self diagnosis
- **Blue fin protection (indoor and outdoor units)**



## Remote controller

- Wireless
- Follow me function
- 5 operation modes (Cool/Heat/Auto/Dry/Fan)
- Sleep mode
- Room temperature setting
- Fan speed selection
- Timer setting function
- Air flow direction setting
- LCD display
- Turbo mode



# Cassette Inverter

YTKE 12 to 18 BZE / YKKE 18 to 55 BZE(O)



## Technical features

Set reference		YTKE_BZEEBMORX					YKKE_BZE(O)				
Indoor unit	Sizes	YTKE 12	YTKE 18	YKKE 18	YKKE 24	YKKE 30	YKKE 36	YKKE 42	YKKE 48	YKKE 55	
Outdoor unit	Sizes	YUKE 12	YUKE 18	YUKE 18	YUKE 24	YUKE 30	YUKE 36	YUKE 42	YUKE 48	YUKE 55	
Cooling capacity	kW	3.5 (0.6-4.4)	5.3 (0.8-6.2)	5.3 (0.8-6.2)	7.0 (1.2-8.2)	8.8 (2.1-10.6)	10.6 (2.9-12.0)	12.3 (3.2-13.2)	13.8 (4.0-16.1)	16.1 (5.0-18.5)	
Heating capacity	kW	4.1 (1.0-5.1)	5.6 (0.9-7.0)	5.7 (0.9-7.0)	7.0 (1.2-8.7)	9.1 (2.1-10.5)	11.1 (2.6-13.2)	13.5 (2.9-14.7)	15.5 (4.2-17.6)	18.2 (5.3-20.5)	
Compressor	Type	Rotary									
Refrigerant		R410A									
Power supply	V/Ph/Hz	230 / 1 / 50					230 / 1 / 50 or 400 / 3 / 50			400 / 3 / 50	
Power input	cooling	kW	0.96	1.63	1.68	2.17	2.76	4.06	4.09	5.15	6.39
	heating	kW	0.99	1.50	1.46	1.90	2.38	3.08	3.53	4.55	5.73
SEER		6.1	6.3	6.3	6.1	6.1	6.1	5.6	5.6	5.6	
SCOP		4.0	4.0	4.0	4.0	4.0	4.0	4.0	4.0	4.0	
Energy Class	cooling	A++	A++	A++	A++	A++	A++	A+	A+	A+	
	heating	A+	A+	A+	A+	A+	A+	A+	A+	A+	
Indoor airflow (H/M/L)	m³/h	650/530/450	660/550/490	1000/800/700	1450/1250/1100	1700/1460/1300	1900/1750/1460	1850/1600/1400	1850/1600/1400	1900/1650/1450	
Sound pressure at 1 m	Indoor (H/M/L)	dB(A)	42 / 38 / 34	46 / 42 / 38	46 / 41 / 37	46 / 42 / 39	53 / 48 / 44	53 / 50 / 47	54 / 51 / 48	53 / 49 / 45	52 / 49 / 46
	Outdoor	dB(A)	57	56.5	56.5	60.5	59.5	61	62.5	65	62.5
Dimensions	Indoor	H (mm)	260	260	205	257	257	257	287	287	287
		W (mm)	570	570	840	840	840	840	840	840	840
		D (mm)	570	570	840	840	840	840	840	840	840
	Outdoor	H (mm)	554	554	554	702	810	810	810	1 333	1 333
		W (mm)	800	800	800	845	946	946	946	952	952
		D (mm)	333	333	333	363	410	410	410	410	410
Panel H / W / D	mm	50 / 647 / 647	50 / 647 / 647	55 / 950 / 950	55 / 950 / 950	55 / 950 / 950	55 / 950 / 950	55 / 950 / 950	55 / 950 / 950	55 / 950 / 950	
Net weight	Indoor unit	kg	18.5	19	26.3	29	31.5	30.6	31.1	32	36
	Outdoor unit	kg	34.5	35.5	35.5	49	62.9	67.2	70.5	95.1	112.8
Piping	Type of connection		Flare								
	Diameter	Gas	3/8"	1/2"	1/2"	5/8"	5/8"	5/8"	5/8"	5/8"	5/8"
Liquid		1/4"	1/4"	1/4"	3/8"	3/8"	3/8"	3/8"	3/8"	3/8"	
Pipe run	Length	m	25	30	30	50	50	65	65	65	65
	Height	m	10	20	20	25	25	30	30	30	30
Operating limits - cooling mode		min/max	-15°C / +50°C								
Operating limits - heating mode		min/max	-15°C / +24°C								

Nominal cooling capacity based on : - Indoor Air Temp. 27°C DB / 19°C WB - Outdoor Air Temp. 35°C DB

Nominal heating capacity based on : - Indoor Air Temp. 21°C DB - Outdoor Air Temp. 7°C DB/6°C WB

Piping length : 5 m with initial charge

Size 36, 42 and 48: Values for single phase models.

## Accessories

Sizes	12	18	18	24	30	36	42	48	55
Wired control									Optional
Central control									Optional



Manufacturer reserves the rights to change specifications without prior notice.

# Blower Inverter Medium Static Pressure

YEKE 12 to 55 BZE(O)

A complete range from 3.5 kW to 15.8 kW



## Features

- High SEER & SCOP, Class A+ or more
- Inverter DC compressor and fan motor
- Washable filter
- Automatic restart
- Condensate pump optional
- Low noise levels
- Wired control
- Low Ambient Kit
- Intelligent defrosting
- Fresh air intake
- Service valve protection cover
- Rustproof casing
- Self diagnosis
- **Blue fin protection (indoor and outdoor units)**



## Wired control

- 5 operation modes (Cool/Heat/Auto/Dry/Fan)
- Sleep mode
- Room temperature setting
- Fan speed selection
- Timer
- LCD display



# Blower Inverter Medium Static Pressure

## YEKE 12 to 55 BZE(O)



### Technical features

Set reference		YEKE_BZE(O)								
Indoor unit	Sizes	YEKE 12	YEKE 18	YEKE 24	YEKE 30	YEKE 36	YEKE 42	YEKE 48	YEKE 55	
Outdoor unit	Sizes	YUKE 12	YUKE 18	YUKE 24	YUKE 30	YUKE 36	YUKE 42	YUKE 48	YUKE 55	
Cooling capacity	kW	3.5 (0.6~4.4)	5.3 (0.8~6.2)	7.0 (1.2~8.2)	8.8 (2.1~10.6)	10.6 (2.9~12.0)	12.3 (3.2~13.2)	14.1 (4.1~16.4)	15.8 (5.0~18.1)	
Heating capacity	kW	3.8 (0.6~5.0)	5.7 (0.9~7.0)	7.0 (1.2~8.7)	9.4 (2.1~10.9)	11.1 (2.6~13.2)	13.5 (2.9~14.7)	16.1 (4.3~18.1)	18.2 (5.3~20.5)	
Compressor	Type	Rotary								
Refrigerant		R410A								
Power supply	V/Ph/Hz	230 / 1 / 50				230 / 1 / 50 or 400 / 3 / 50			400 / 3 / 50	
Power input	cooling	kW	1.03	1.68	2.28	2.87	3.96	4.09	5.11	5.25
	heating	kW	0.95	1.46	1.90	2.46	2.92	3.53	4.35	5.03
SEER			6.1	6.5	6.1	6.1	6.3	5.6	6.1	6.1
SCOP			4.0	4.0	4.0	4.0	4.0	4.0	4.0	4.0
Energy Class	cooling		A++	A++	A++	A++	A++	A+	A++	A++
	heating		A+	A+	A+	A+	A+	A+	A+	A+
Indoor airflow	m³/h	680 / 580 / 450	1050 / 900 / 780	1360 / 1200 / 970	1580 / 1400 / 1100	1750 / 1500 / 1280	2200 / 1900 / 1600	2200 / 1900 / 1600	2200 / 1900 / 1600	
External static pressure	Pa	0 / 45	0 / 100	0 / 100	0 / 100	0 / 100	0 / 100	0 / 100	0 / 100	
Sound pressure at 1 m	Indoor (H/M/L)	dB(A)	42 / 38 / 35	44 / 40 / 37	46 / 42 / 38	50 / 48 / 44	48 / 45 / 40	50 / 47 / 44	51 / 48 / 45	50 / 47 / 45
	Outdoor	dB(A)	57	56.5	60.5	59.5	61	62.5	65	62.5
Dimensions	Indoor	H (mm)	210	270	270	270	300	300	300	300
		W (mm)	700	920	920	1 140	1 200	1 200	1 200	1 200
		D (mm)	635	635	635	775	865	865	865	865
	Outdoor	H (mm)	554	554	702	810	810	810	1 333	1 333
		W (mm)	800	800	845	946	946	946	952	952
		D (mm)	333	333	363	410	410	410	410	410
Net weight	Indoor unit	kg	18.4	26.9	28	35	45	43.4	43.2	43.1
	Outdoor unit	kg	34.5	35.5	49	62.9	67.2	70.5	95.1	112.8
Piping	Type of connection		Flare							
	Diameter	Gas	3/8"	1/2"	5/8"	5/8"	5/8"	5/8"	5/8"	5/8"
	Liquid	1/4"	1/4"	3/8"	3/8"	3/8"	3/8"	3/8"	3/8"	
Pipe run	Length	m	25	30	50	50	65	65	65	65
	Height	m	10	20	25	25	30	30	30	30
Operating limits - cooling mode	min/max	-15°C / +50°C								
Operating limits - heating mode	min/max	-15°C / +24°C								

Nominal cooling capacity based on : - Indoor Air Temp. 27°C DB / 19°C WB - Outdoor Air Temp. 35°C DB

Nominal heating capacity based on : - Indoor Air Temp. 21°C DB - Outdoor Air Temp. 7°C DB/6°C WB

Piping length : 5 m with initial charge

Size 36, 42 and 48: Values for single phase models.

### Accessories

Sizes	12	18	24	30	36	42	48	55
Condensate pump								Optional
Central control								Optional



Manufacturer reserves the rights to change specifications without prior notice.





# VRF Systems

HIGH EFFICIENCY SERIES

AMAZON STANDARD SERIES

INDOOR UNIT TYPES

# VRF System High Efficiency

YV2VYH 025 to 204

Cooling capacities 25.4 kW to 211.2 kW



## VRF System

- Capacities from 25.4 to 211.2 kW
- Operating range of nominal power (10% - 130 %)
- DC Inverter Scroll Compressor
- Low noise levels
- High Efficiency. EER up to 4.29
- Modular design
- Long piping design up to 1000 m
- Big height difference design: 90 m
- Height difference between indoors: 18 m
- Large indoor unit combinations
- Flexible and quickly installation

## Comfort – Quality

- Cooling and heating
- Connection up to 64 indoor units per refrigeration circuit (3 outdoor units)
- Complete range in R410A
- Reduced footprint
- Is appropriate particularly for existing buildings
- Cooling to -5°C to +43°C (outdoor temperature)
- Heating to -15°C to +24°C (outdoor temperature)

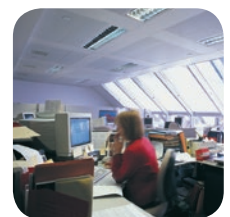

### YV2VYH Technical features – Single module outdoor unit

Model		YV2VYH025	YV2VYH028	YV2VYH033	YV2VYH040	YV2VYH045	YV2VYH050	YV2VYH056	YV2VYH061	YV2VYH068
Cooling capacity	kW	25.4	28.9	34.8	41.5	46.4	51.5	57.8	63.7	70.4
EER		4.29	4.00	3.90	3.55	3.47	3.42	3.34	3.18	3.09
Heating capacity	kW	28.1	32.4	37.9	45.8	51.1	57.2	63.7	70.1	73.9
COP		4.30	4.19	3.71	3.84	3.82	3.74	3.75	3.73	3.83
Air flow in cooling	m³/h	15 000	15 000	15 000	15 000	15 600	16 200	16 200	16 200	16 200
Sound Pressure Level at 1 m	dB(A)	57	57	59	59,5	61	62	62	62	63

Electrical features										
Power supply		380V-3-50/60Hz								
Power input "cooling"	kW	5.87	7.00	8.60	11.27	12.97	14.73	16.79	19.37	21.98
Power input "heating"	kW	6.28	7.52	10.12	11.73	13.10	15.12	16.79	18.48	19.08
Compressor	Type	DC Inverter Scroll				2 x DC Inverter Scroll				

Dimensions and Weight										
Height x Width x Length	mm	1690x1350x720	1690x1350x720	1690x1350x720	1690x1350x720	1690x1350x720	2048x1350x720	2048x1350x720	2048x1350x720	2048x1350x720
Weight	kg	278	278	278	282	324	343	343	369	369

Piping connections										
Gas		1"	1"	1"	1" 1/4"	1" 1/4"	1" 1/4"	1" 1/4"	1" 1/4"	1" 1/4"
Liquid		1/2"	1/2"	1/2"	1/2"	1/2"	1/2"	1/2"	1/2"	1/2"
Refrigerant charge	Type	R410A								
	kg	10	10	10	10	10	10	10	10	10

Piping length / Height difference										
Max. piping length farthest indoor unit (m)		190								
Max. height difference indoor/outdoor (m)		50								
Max. number of indoor units		13	16	20	24	27	30	33	36	40

Models available to be confirmed as soon as they are launched (estimated Mar'15)

### Combination of modular outdoor units

Model	074	080	085	090	095	101	106	112	118	124	130	136	141	146	151	157	162	168	174	180	186	192	198	204
Capacity Cooling kW	76.3	83.0	87.9	93.0	97.9	104.2	109.3	115.6	121.5	128.2	140.0	140.8	144.5	150.6	155.7	162.0	167.1	173.4	179.3	186.0	191.9	198.6	204.5	211.2
Capacity Heating kW	83.7	91.6	96.9	103.0	108.3	114.8	120.9	127.4	133.8	137.6	144.0	147.8	160.2	165.9	172.0	178.5	184.6	191.1	197.5	201.3	207.7	211.5	217.9	221.7
Maximum indoor units	43	46	50	53	57	60	64	64	64	64	64	64	64	64	64	64	64	64	64	64	64	64	64	64
Appearance																								

### DX-Kit Available for all type of 2-pipe outdoor units

York offers a range of connection kit to connect VRF outdoor units to third party DX air handling units.

Two models availables:

- YAH1-280A (up to 28 kW)
- YAH1-560A (up to 56 kW)

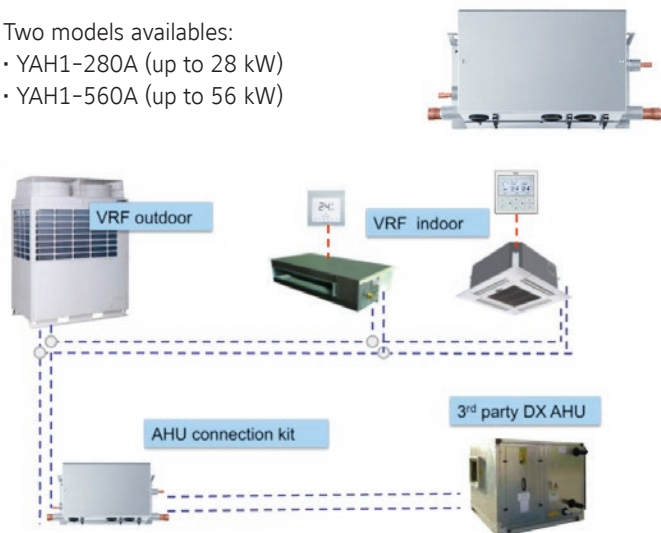

### YCZ-G001 Central Controller

Available for all type of outdoor units

- Max. 32 indoor units control.
- Max. 32 outdoor units control.
- On/Off, Mode, Fan speed, Temperature setting, Swing.
- Individual control, Group control & Central control (Max. 32 indoor units)
- Color interface with back light
- Large touch key
- Fahrenheit/Celsius selectable
- Weekly timer
- Unit name & Group name free setting. Four background available (mall, hotel, office, home)
- Error display
- Together with one IGU05 per outdoor unit



CE Manufacturer reserves the rights to change specifications without prior notice.

# Amazon Standard Ambient VRF System

YV2V 010 to 135

Cooling capacities 9 kW to 135 kW



## VRF System

- Capacities from 9 to 135 kW
- Operating range of nominal power (10% - 130 %)
- DC Inverter Scroll Compressor
- Low noise levels
- High Efficiency. EER up to 4.28
- Modular design
- Large indoor unit combinations
- Flexible and quickly installation

## Comfort – Quality

- Cooling and heating
- Connection up to 64 indoor units per refrigeration circuit (3 outdoor units)
- Complete range in R410A
- Reduced space of ground
- Is appropriate particularly for existing buildings
- Cooling to -5°C to +43°C (outdoor temperature)
- Heating to -15°C to +24°C (outdoor temperature)

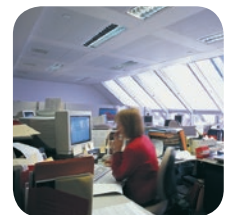

### YV2V Technical features – Mini-VRF outdoor unit

Model		YV2VYH010KAR	YV2VYH015KAR	YV2VYH015KAS	YV2VYH018KAS
Cooling capacity	kW	9.0	15.0	15.0	18.0
EER		2.98	3.33	3.06	2.84
Heating capacity	kW	11.0	17.0	17.0	20.0
COP		4.20	3.78	3.95	3.37
Air flow	m³/h	3 500	6 500	6 500	6 500
Sound Pressure Level at 1 m	dB(A)	58	59	59	60
<b>Electrical features</b>					
Power supply		1/N/ 230V 50Hz		3/N/ 400V 50Hz	
Power input "cooling"	kW	3.02	4.50	4.90	6.33
Power input "heating"	kW	2.62	4.50	4.30	5.93
Compressor	Type	Rotary	Rotary	Rotary	Rotary
<b>Dimensions and Weight</b>					
Height x Width x Length	mm	830 x 960 x 380	1 250 x 960 x 380	1 250 x 960 x 380	1 250 x 960 x 380
Weight	kg	74	120	120	120
<b>Piping connections</b>					
Gas		5/8"	3/4"	3/4"	3/4"
Liquid		3/8"	3/8"	3/8"	3/8"
Refrigerant charge	Type	R410A			
	kg	2.6	3.6	4	4
<b>Piping length / Height difference</b>					
Max. piping length	m	50	100	100	100
Max. height difference	m	30	30	30	30
Max. number of indoor units		4	8	8	9

### YV2V Technical features – Single module outdoor unit

Model		YV2VYH022KAS	YV2VYH028KAS	YV2VYH033KAS	YV2VYH040KAS	YV2VYH045KAS
Cooling capacity	kW	22.6	28.0	33.5	40.0	45.0
EER		4.28	3.80	3.35	3.51	3.36
Heating capacity	kW	25.0	31.5	37.5	45.0	50.0
COP		4.24	3.95	3.75	3.88	3.70
Air flow	m³/h	11.100	11.100	14.100	14.100	14.100
Sound Pressure Level at 1 m	dB(A)	57	57	60	60	60
<b>Electrical features</b>						
Power supply		3/N/ 400V 50Hz				
Power input "cooling"	kW	5.27	7.36	10.00	11.40	13.40
Power input "heating"	kW	5.89	7.97	10.00	11.60	13.50
Compressor	Type	DC Inverter Scroll		DC Inverter Scroll + Standard Scroll		
<b>Dimensions and Weight</b>						
Height x Width x Length	mm	1 808 x 990 x 750	1 808 x 990 x 751	1 808 x 1 390 x 750	1 808 x 1 390 x 751	1 808 x 1 390 x 752
Weight	kg	240	240	360	360	368
<b>Piping connections</b>						
Gas		3/4"	7/8"	1"	1"	1 1/8"
Liquid		3/8"	3/8"	1/2"	1/2"	1/2"
Refrigerant charge	Type	R410A				
	kg	10	10	10	10	10
<b>Piping length / Height difference</b>						
Max. piping length farthest indoor unit (m)		175				
Max. height difference indoor/outdoor (m)		50				
Max. number of indoor units		13	16	19	23	26

### Combination of modular outdoor units

Model	050	056	061	068	073	078	085	090	096	101	106	113	118	123	130	135	
Capacity	Cooling kW	50.6	56.0	61.5	68.0	73.0	78.5	85.0	90.0	96.0	101.0	106.5	113.0	118.0	123.5	130.0	135.0
	Heating kW	56.5	63.0	69.0	76.5	81.5	90.0	95.0	100.0	108.0	113.0	121.5	126.5	131.5	137.5	145.0	150.0
Maximum indoor units		29	33	36	39	43	46	50	53	56	59	63	64	64	64	64	64
Appearance																	

CE Manufacturer reserves the rights to change specifications without prior notice.

# VRF Heat recovery system

YV2V 024 to 045



## YV2V 3 Pipes Technical features - Single module outdoor unit

Model	YV2VYT024KAS-D-X	YV2VYT029KAS	YV2VYT035KAS	YV2VYT042KAS	YV2VYT045KAS	
Cooling capacity	kW	23.9	29.3	35.1	41.7	45.0
EER		4.02	3.84	3.82	3.42	3.23
Heating capacity	kW	26.5	32.8	39.2	46.8	50.7
COP		4.3	4.1	4.2	4.1	3.8
Air flow	m <sup>3</sup> /h	11.100	11.100	14.100	14.100	14.100
Sound Pressure Level at 1 m	dB(A)	57	57	60	60	60
<b>Electrical features</b>						
Power supply		3/N/ 400V 50Hz				
Power input "cooling"	kW	6.0	7.6	9.2	12.2	14.0
Power input "heating"	kW	6.2	8.0	9.2	11.4	13.4
Compressor	Type	DC Inverter Scroll		DC Inverter Scroll + Standard Scroll		
<b>Dimensions and Weight</b>						
Height x Width x Length	mm	1 808 x 990 x 750	1 808 x 990 x 750	1 808 x 1 390 x 750	1 808 x 1 390 x 750	1 808 x 1 390 x 750
Weight	kg	240	240	368	368	368
<b>Piping connections</b>						
Gas		3/4" / 3/4"	7/8" / 3/4"	1" / 7/8"	1" / 7/8"	1 1/8" / 1"
Liquid		3/8"	3/8"	1/2"	1/2"	1/2"
Refrigerant charge	Type	R410A				
	kg	10	10	10	10	10
<b>Piping length / Height difference</b>						
Max. piping length farthest indoor unit (m)		175				
Max. height difference indoor/outdoor (m)		50				
Max. number of indoor units		13	16	19	23	26

## Combination of modular outdoor units

HP	8	10	12	15	16	18	20	22	24	26	28	30	32	34	36	38	40	42	44	46	48	
<b>Capacity</b>																						
Coolin kW	23.9	29.3	35.1	41.7	45.0	53.2	58.6	64.4	71.0	74.3	83.4	86.7	90.0	100.3	103.6	112.7	116.0	119.3	125.1	131.7	135.0	
Heating kW	26.5	32.8	39.2	46.8	50.7	59.3	65.6	72.0	79.6	83.5	93.6	97.5	101.4	112.4	116.3	126.4	130.3	134.2	140.6	148.2	152.1	
<b>Maximum indoor units</b>	13	16	19	23	26	29	33	36	39	43	46	50	53	56	59	63	64	64	64	64	64	
<b>Appearance</b>																						

## Technical features - Heat recovery valve box

Model	VB1-112A	VB1-180A	VB1-280A	
<b>Capacity</b>				
Power supply	3/N/ 400V 50Hz			
Total Capacity Index of Indoor Units	kW	≤ 11.2	> 11.2 & ≤ 18.0	> 18.0 & ≤ 28.0
Number of Connectable Indoor Units		Max. 5	Max. 8	Max. 8
<b>Piping connection</b>				
Liquid pipe - Connect to indoor unit	mm	3/8"	3/8"	3/8"
Gas pipe -Connect to indoor unit	mm	5/8"	5/8"	7/8"
Liquid pipe-Connect to outdoor unit	mm	3/8"	3/8"	3/8"
Suction pipe-Connect to outdoor unit	mm	5/8"	5/8"	1"
High pressure gas pipe-Connect to outdoor unit	mm	1/2"	5/8"	3/4"
<b>Dimensions &amp; Weight</b>				
Height x Width x Length	mm	180 x 400 x 300	180 x 400 x 300	180 x 400 x 300
Weight	kg	12	12	13

# VRF Heat recovery system

## Heat recovery valve box scheme

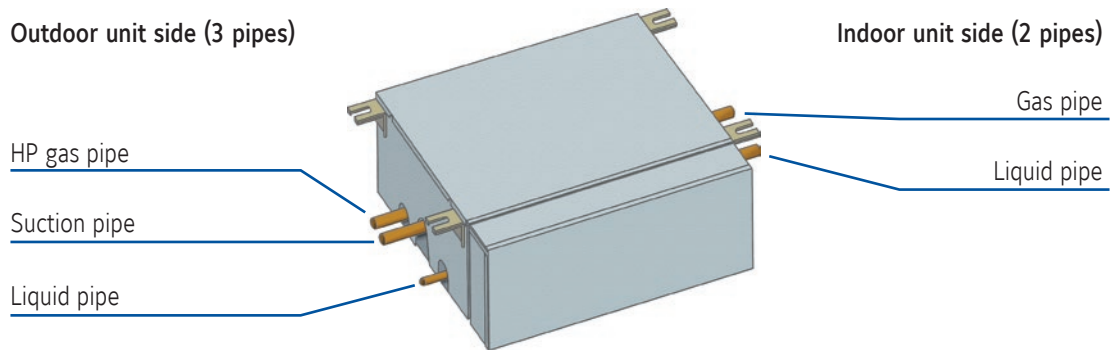

## Cooling and heating synchronously in one system

Heat recovery system can achieve cooling and heating synchronously in one system by valve box device.

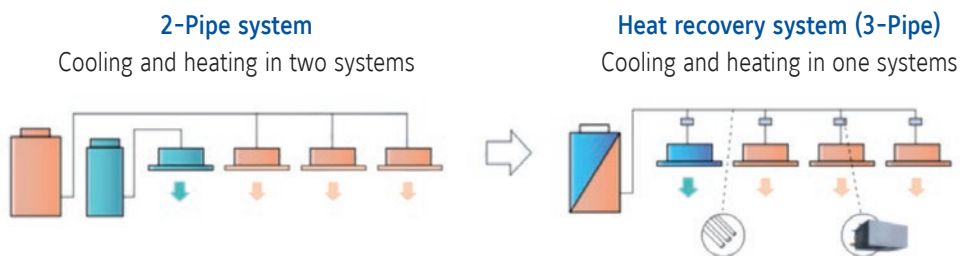

## Heat Recovery, More Energy-saving

The surplus heat of some indoor units' condensation can be used for other indoor units for evaporation. Comparing with traditional Air Conditioning system, save at least 15% energy.

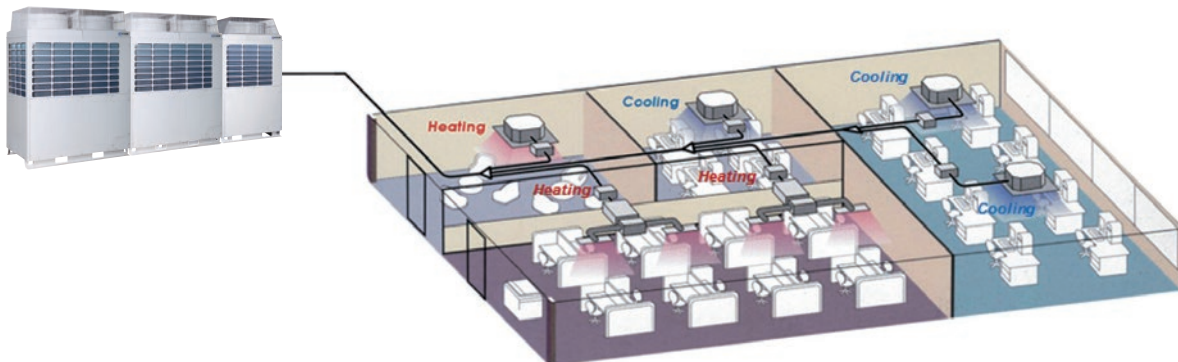

CE Manufacturer reserves the rights to change specifications without prior notice.

# VRF Technical features indoor units



## High wall (EXV integrated)

Model			YVHVXH022	YVHVXH028	YVHVXH036	YVHVXH045	YVHVXH056	YVHVXH071
Capacity	Cooling	kW	2.2	2.8	3.6	4.5	5.6	7.1
	Heating	kW	2.5	3.2	4.0	5.0	6.3	8.0
	Air flow	m³/h	600					800
Noise level at 1 m	H / M / L	dB(A)	37 / 33 / 31	37 / 34 / 31	41 / 36 / 33	41 / 36 / 33	43 / 39 / 34	48 / 39 / 37
Electrical features	Power supply	V/Ph/Hz	230 / 1 / 50 + N + E					
	Current	A	0.31				0.41	
Dimensions and Weight	H x W x D	mm	265 x 938 x 187				299 x 1 046 x 239	
	Weight	kg	10.9				13	
Piping	Gas		1/2"				5/8"	
	Liquid		1/4"				3/8"	



## Cassette

Model			YVKVXH028	YVKVXH036	YVKVXH045	YVKVXH056	YVKVXH071	YVKVXH080	YVKVXH090	YVKVXH112	YVKVXH140
Capacity	Cooling	kW	2.8	3.6	4.5	5.6	7.1	8.0	9.0	11.2	14.0
	Heating	kW	3.2	4.0	5.0	6.3	8.0	9.0	10.0	12.5	16.0
	Air flow	m³/h	700	650		1 200			1 800		
Noise level at 1 m	H / M / L	dB(A)	32 / 30 / 29	32 / 30 / 29	33 / 30 / 29	34 / 32 / 30	35 / 34 / 31	37 / 35 / 31	37 / 35 / 31	37 / 35 / 31	44 / 40 / 36
Electrical features	Power supply	V/Ph/Hz	230 / 1 / 50 + N + E								
	Current	A	0.47			0.67			0.76		
Dimensions and Weight	H x W x D	mm	260 x 570 x 570			240 x 840 x 840			295 x 840 x 840		
	Weight	kg	17			30			38		
Panel	H x W x D	mm	60 x 700 x 700			80 x 950 x 950					
	Weight	kg	2.8			6					
Piping	Gas		3/8"	1/2"			5/8"				
	Liquid		1/4"	1/4"			3/8"				



## Convertible console floor/ceiling

Model			YVFXH028	YVFXH036	YVFXH045	YVFXH056	YVFXH071	YVFXH112	YVFXH140	
Capacity	Cooling	kW	2.8	3.6	4.5	5.6	7.1	11.2	14.0	
	Heating	kW	3.2	4.0	5.0	6.3	8.0	12.5	16.0	
	Air flow	m³/h	800					2 040		
Noise level at 1 m	H / M / L	dB(A)	48 / 46 / 44					50 / 48 / 46		53 / 51 / 49
Electrical features	Power supply	V/Ph/Hz	230 / 1 / 50 + N + E							
	Current	A	0.3					1.8		
Dimensions and Weight	H x W x D	mm	655 x 990 x 199					700 x 1 580 x 240		
	Weight	kg	38.3					54		
Piping	Gas		3/8"	1/2"			5/8"			
	Liquid		1/4"	1/4"			3/8"			



## Console

Model			YV5VXH022	YV5VXH028	YV5VXH036	YV5VXH056
Capacity	Cooling	kW	2.2	2.8	3.6	5.0
	Heating	kW	2.5	3.2	4.0	6.0
	Air flow	m³/h	460		520	580
Noise level at 1 m	H / M / L	dB(A)	43 / 39 / 36			48 / 46 / 42
Electrical features	Power supply	V/Ph/Hz	230 / 1 / 50 + N + E			
	Current	A	0.44			
Dimensions and Weight	H x W x D	mm	640 x 720 x 255			
	Weight	kg	18			
Piping	Gas		1/2"			
	Liquid		1/4"			



# VRF Technical features indoor units



## Low and Medium Static Pressure Duct

Model		Low Static Pressure						Medium Static Pressure							
		YVDVXH022	YVDVXH028	YVDVXH036	YVDVXH045	YVDVXH056	YVDVXH071	YVEVXH056	YVEVXH071	YVEVXH080	YVEVXH090	YVEVXH112	YVEVXH114		
Capacity	Cooling	kW		2.2	2.8	3.6	4.5	5.6	7.1	5.6	7.1	8.0	9.0	11.2	14.0
	Heating	kW		2.5	3.2	4.0	5.0	6.3	8.0	7.1	8.0	9.0	10.0	12.5	16.0
	Air flow	m³/h		400		500	850	1 250		1 200		1 900		2 100	
Noise level at 1 m	H / M / L	dB(A)		35 / 32 / 30			39 / 37 / 35			43 / 37 / 35			44 / 40 / 36		
External static pressure	Pa		0 - 20						50 - 96			80 - 120			
Electrical features	Power supply	V/Ph/Hz		230 / 1 / 50 + N + E											
	Current	A		0.27		0.38	0.55		1.1			2.2			
Dimensions and Weight	H x W x D	mm		220 / 610 / 500			220 / 1 105 / 500			300 / 1 180 / 743			270 / 1 135 / 742		
	Weight	kg		15	16	25	28		39			50			
Piping	Gas	3/8"		1/2"			5/8"		1/2"		5/8"				
	Liquid	1/4"		1/4"			3/8"		1/4"		3/8"				



## High Static Pressure Duct

Model		YVGVXH056	YVGVXH071	YVGVXH080	YVGVXH090	YVGVXH112	YVGVXH140	YVGVXH226	YVGVXH280		
Capacity	Cooling	kW		5.6	7.1	8.0	9.0	11.2	14.0	22.6	28.0
	Heating	kW		6.3	8.0	9.0	10.0	12.5	16.0	25.0	31.6
	Air flow	m³/h		1 500			1 560	1 600	2 100	4 050	
Noise level at 1 m	H / L	dB(A)		42 / 40			45 / 40			54 / 49	
External static pressure	Pa		100								
Electrical features	Power supply	V/Ph/Hz		230 / 1 / 50 + N + E							
	Current	A		2.05			2.55			5.05	
Dimensions and Weight	H x W x D	mm		360 x 970 x 875			360 x 1 350 x 875			360 x 1 610 x 840	
	Weight	kg		48			62			92	
Piping	Gas	1/2"		5/8"			1"			3/8"	
	Liquid	1/4"		3/8"			3/8"			3/8"	



## Fresh Air Unit

Model		YV4VXH140	YV4VXH226	YV4VXH280		
Capacity	Cooling	kW		14.0	22.6	28.0
	Heating	kW		8.9	15.2	17.8
	Air flow	m³/h		1 600	2 300	2 800
Noise level at 1 m	High speed	dB(A)		48	55	
External static pressure	Pa		100			
Electrical features	Power supply	V/Ph/Hz		230 / 1 / 50 + N + E		
	H x W x D	mm		360 x 1 350 x 875	360 x 1 750 x 840	
Dimensions and Weight	Weight	kg		62	120	
	Gas	5/8"		1"		
Piping	Liquid	3/8"		3/8"		



## Heat Recovery Ventilator

Model		YV6VXH015	YV6VXH026	YV6VXH080	YV6VXH100		
Air flow	m³/h	150	200	800	1 000		
External static pressure	Pa	50	60	80	100		
Power supply	V/Ph/Hz	230 / 1 / 50 + N + E					
Dimensions and Weight	H x W x D	mm		276x940x685	276x940x686	387x1227x1115	387x1227x1116
	Weight	kg		28.7		85.5	

CE Manufacturer reserves the rights to change specifications without prior notice.

# Controllers & BMS

## YR-H71 Wireless Controller

Elegant and slim design, LCD display, 4 Operation modes (Cool/Dry/Heat/Fan), Timer ON/OFF setting up to 24 Hr., Temperature control range, Fan speed selection. Standard for High Wall and Console, optional for Duct, Cassette and Floor Ceiling.



## YR-E17 Wired Controller

Exclusive design, Big LCD display, 4 Operation modes (Cool/Dry/Heat/Fan), Temperature setting, Timer setting, Fan speed selection, Group controller up to 16 indoor units. Standard for Duct, Cassette and Floor Ceiling. **Optional** for High Wall and **NO optional** for Console.



## YCZ-A003 Touch Screen Central Controller

Max. 128 indoor units control. Single or all query and control, such as ON/OFF/Mode setting/Temp setting/ Fan setting ect. Mode lock function, Blue light background, LCD display screen.



## IGU05 Touch Screen Central Controller Translator

Translating protocol between home bus and RS485. Connecting with one outdoor (combination model also regard as one) system. Work with Touch Screen Central Controller



## HCM-01 Central Controller With Monitor Software

Max. 128 indoor units control. Single or all query and control, such as ON/OFF/Mode setting/Temp setting/ Fan setting ect. Mode lock function, Blue light background, Software Monitoring on any PC.



## IGU02 BacNet/IP Translator

Translating protocol between home bus and RS485. Connecting with one outdoor (combination model also regard as one) system. Work with Central Controller with Monitor Software and BacNet/IP Converter.



## IGU06 LonWorks Translator

Translating protocol between home bus and RS485. Connecting with one outdoor (combination model also regard as one) system. Work with LonWorks Converter.



## HCM-04 BacNet/IP Converter

Max. 60 indoor units control. Connect A/C system to BMS by BacNet/IP protocol.



## IGU07 LonWorks Converter

Max. 32 indoor units control. Connect A/C system to BMS by LONWORKS protocol.



# VRF System – System Diagram

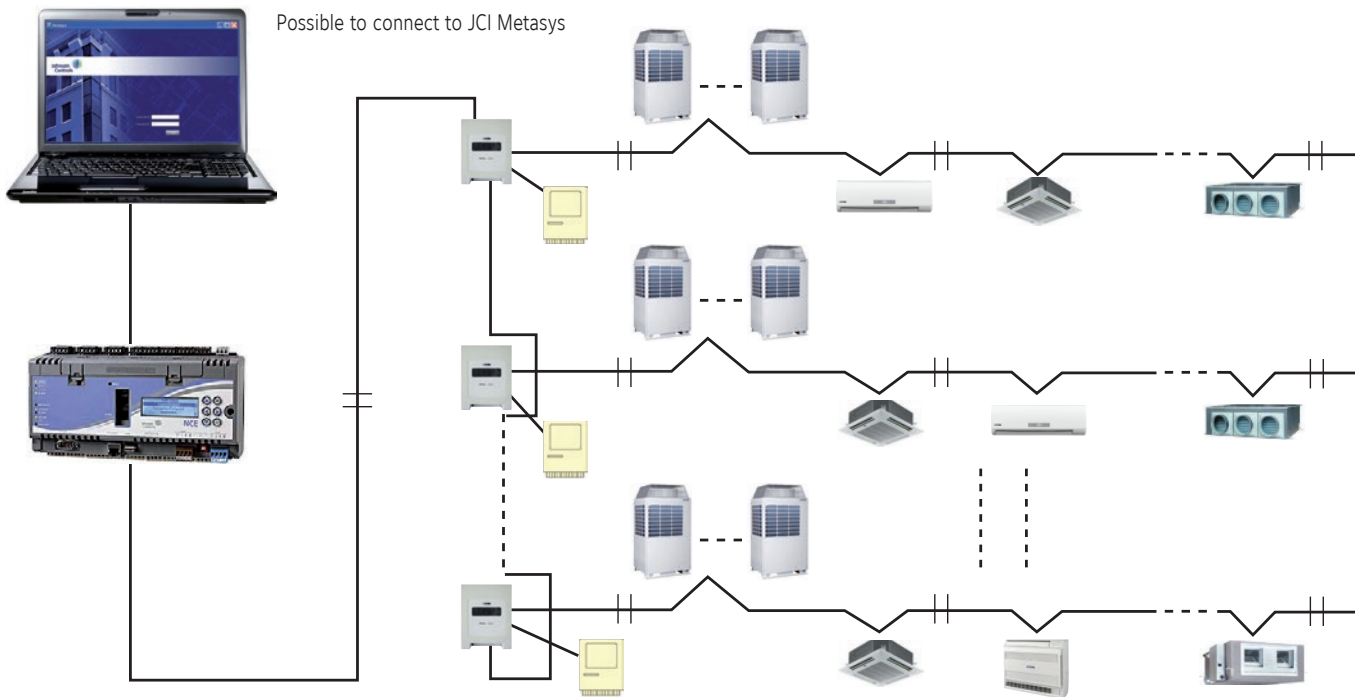

## Piping accessories

Model	System	Name	Function	Application
FQG-B335A	2 pipes	Indoor manifold pipe	Refrigerant distribution	Total indoor units capacity < 33.5 kW
FQG-B506A	2 pipes	Indoor manifold pipe	Refrigerant distribution	33.5 kW ≤ Total indoor units capacity < 50.6 kW
FQG-B730A	2 pipes	Indoor manifold pipe	Refrigerant distribution	50.6 kW ≤ Total indoor units capacity < 72 kW
FQG-B1350A	2 pipes	Indoor manifold pipe	Refrigerant distribution	73 kW ≤ Total indoor units capacity
HZG-20A	2 pipes	Outdoor branch pipe	Refrigerant gathering	2 module combinations
HZG-30A	2 pipes	Outdoor branch pipe	Refrigerant gathering	3 module combinations
HZG-20B	2 pipes HE	Outdoor HE branch pipe	Refrigerant gathering	2 module HE combinations
HZG-30B	2 pipes HE	Outdoor HE branch pipe	Refrigerant gathering	3 module HE combinations
FQG-R335A	3 pipes	Indoor manifold pipe	Refrigerant distribution	Total indoor units capacity < 33.5 kW
FQG-R506A	3 pipes	Indoor manifold pipe	Refrigerant distribution	33.5 kW ≤ Total indoor units capacity < 50.6 kW
FQG-R730A	3 pipes	Indoor manifold pipe	Refrigerant distribution	50.6 kW ≤ Total indoor units capacity < 72 kW
FQG-R1350A	3 pipes	Indoor manifold pipe	Refrigerant distribution	73 kW ≤ Total indoor units capacity
HZG-R20A	3 pipes	Outdoor branch pipe	Refrigerant gathering	2 module combinations
HZG-R30A	3 pipes	Outdoor branch pipe	Refrigerant gathering	3 module combinations

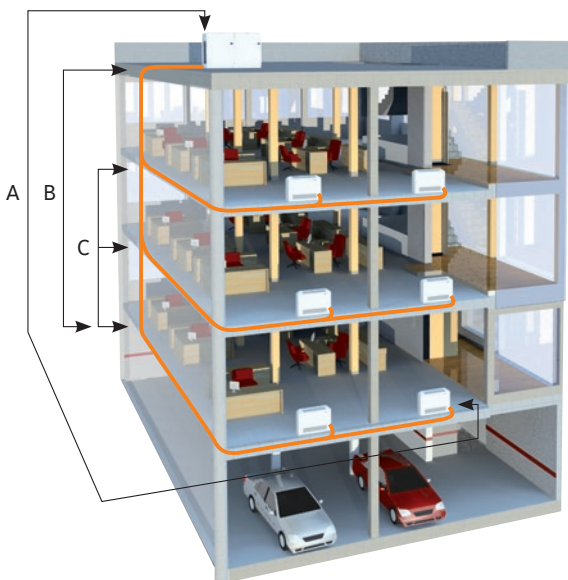

## YORK VRF System

The YORK VRF system with DC Inverter Scroll is working like the VRF principle and offers you economical air-conditioning system for projects, which are requiring more capacity than the normal split and multi split solutions.

The lengths for the connecting tubes between the indoor and outdoor have been prolonged, which brings you more flexible solutions for complex air-conditioning projects.

A – Maximum single way pipe length: 175m

B – Maximum difference in height: 50m  
(110m for HE outdoor units)

C – Maximum difference in height between 2 indoor units: 15m  
(30m for HE outdoor units)



### **About Johnson Controls**

Johnson Controls delivers products, services and solutions that increase energy efficiency and lower operating costs in buildings for more than one million customers.

Operating from 500 branch offices in more than 150 countries, the company is a leading provider of equipment, controls and services for heating, ventilating, air-conditioning, refrigeration and security systems. Johnson Controls is involved in more than 500 renewable energy projects including solar, wind and geothermal technologies.

Its solutions have reduced carbon dioxide emissions by 13.6 million metric tons and generated savings of \$7.5 billion since 2000. Many of the world's largest companies rely on Johnson Controls to manage 1.5 billion square feet of their commercial real estate.

